

ALINCO

VHF/FM HANDY TRANSCEIVER

DJ-162 Series

INSTRUCTION MANUAL

ALINCO ELECTRONICS INC.

438 Amapola Ave., Lot 130, Torrance Ca. 90501, U.S.A.

Phone: (213) 618-8616

※ Area Code will be changed to (310) from (213) on 2nd Nov. 1991.

1-1-1 Mishimae, Takatsuki city, Osaka 569, Japan

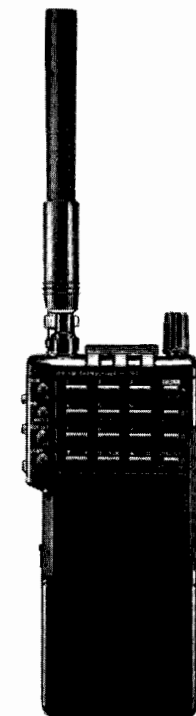

 **ALINCO**
ELECTRONICS INC.

TABLE OF CONTENTS

Introduction	3
Accessories	3
Specifications	4
Operations	5
Control Functions	5
Frequency Selection	10
Receiving & Transmitting	11
VFO Mode & Memory Mode	11
Memory Operation	12
Scan Function	13
Repeater Operation	15
Offset Selection	15
Tone Frequency Selection	16
Shift Selection	16
Channel Step Selection	17
(Scan Function) [see above]	17
(a) Band Scan Function	18
(b) Program Scan Function	18
(c) Memory Scan Function	18
Priority Function	18
(a) VFO Priority	18
(b) Memory Priority	19
(c) Call Priority	20
Simultaneous priority Operation	20
Dual Watch Function	21
Reverse Function	22
Tone Encoder	22
Tone Squelch	23
DSQ Function	24
Code Squelch Function	24
DSQ Code	24
(a) DSQ Code Selection	24
(b) DSQ Selection	25
Dial Function	28
Auto Dialer Function	29
Frequency Lock Function	29
PTT Key Lock Function	29
Lamp Function	29
Auto Battery Save Function	29
Auto Power Off Function	29
Squelch Off Function	29
Reset Function	30

INTRODUCTION

Congratulations, now you are the owner of one of our many "ALINCO" products. Your DJ-162 has been manufactured and tested very carefully at the factory and will give you many years of satisfactory operations.

ACCESSORIES AVAILABLE FOR THE DJ-162

OPTIONS for DJ-162 Series

ITEM	DESCRIPTION	DJ-162TD	DJ-162ED
A	EBP-10NA 7.2 V 700 mAH NiCd	×	×
B	EBP-12NA 12 V 700 mAH NiCd	×	×
C	EDC-17 (220 V) Wall Charger for EBP-10NA	×	×
D	EDC-21 (120 V) Wall Charger for EBP-10NA	×	×
E	EDC-18 (220 V) Wall Charger for EBP-12NA	×	×
F	EDC-22 (120 V) Wall Charger for EBP-12NA	×	×
G	EBC-1 Belt Clip	○	○
H	EDH-1 Dry Cell Battery Case	○	○
I	EDC-34 (110 V) AC/DC Quick Charger	×	×
J	EDC-35 (220 V) AC/DC Quick Charger	×	×

○: standard Accessories
×: optional Accessories

SPECIFICATIONS

■ GENERAL

Frequency Coverage: 144–146 MHz (DJ-162ED)
144–148 MHz (DJ-162TD)

Emission Type: 16F3

Antenna Impedance: 50 Ohm

Operating Voltage: rated 9 V

Operating Current: High (3 W): 900 mA
Low (0.3 W): 400 mA

Dimensions: 142 (H)×57 (W)×32 (D) mm

Weight: Approx. 350 g

■ RECEIVER

Type: Dual Conversion; 1st IF: 55.05 MHz; 2nd IF: 455 kHz

Sensitivity: 12 dB SINAD less than –15 dB μ

Selectivity: More than ± 7.5 kHz at –6 dB
Less than ± 15 kHz at –60 dB

Squelch Sensitivity: Less than –15 dB μ

Audio Output: More than 250 mW (10% THD), 8 ohms

■ TRANSMITTER

Output Power: See table

Modulation: Variable reactance FM

Maximum Deviation: ± 5 kHz

Harmonic Suppression: –60 dB

Microphone: Built-in electret condenser

Operating Modes: Simplex
Shifted + or – 600 kHz

RF POWER OUTPUT TABLE		
Battery	Hi	Lo
EBP-10NA EBP-12NA	2 W 5 W	Approx 0.2 W Approx 0.5 W

OPERATION

Control Functions

Top View

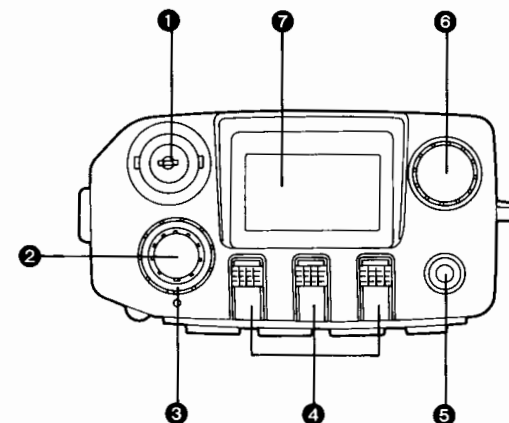

① BNC Antenna Connector

Attach 50 Ohm antenna to connector

② ON/OFF Volume Control

In the full counter clockwise position, power is OFF. Rotate clockwise to turn on and increase audio.

③ Squelch Control

When no signal is present in the receive mode, adjust squelch control clockwise until noise threshold is reached.

④ UP/DOWN Key

 Key is used to change memory number (Number will decrease if Function Key is held).

 Key is used to change 1 MHz. (Number will decrease if Function Key is held.)

 Key is used to change 100 kHz. (Number will decrease if Function Key is held.)

⑤ Speaker Jack

This Jack is for an External Speaker.

⑥ Dial

This dial is used to change frequency by channel step in VFO mode. It can also be used to change memory number in Memory mode.

⑦ LCD

Front, Back, and Side View

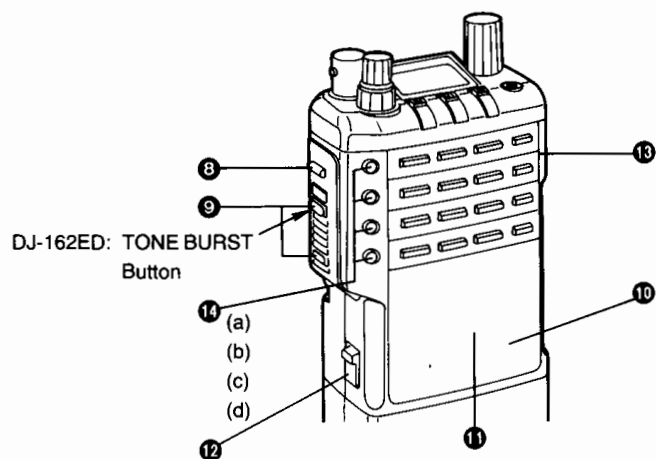

DJ-162ED: TONE BURST Button

8 Function (F) Key

This key is used to access all secondary function. Press the "F" key and hold, then press the command key desired. Also this key is used to put the unit in the reset mode (See reset function).

9 PTT (Press To Talk)

Press this button for transmission and speak into the microphone.

10 Microphone

An electric condenser microphone is built-in. Speak into the microphone at a distance of appx. 5" when transmitting.

11 Speaker

12 Battery Release Button

This button is used to release the battery pack from the radio.

- (1) To attach the battery pack to the unit: Put the unit on the battery pack shown below and slide the battery pack to the right side.



- (2) To release the battery pack from the unit. Slide up and hold the release button and then slide the battery pack to the charging jack side.

13 16 Key front touch pad

14 4 Key Side Touch Pad

- (a) V/M M (VFO/Memory M) key
Rotating the Dial will change the Memory Number in the Memory Mode, or VFO mode. Press and hold the F key then press the M key to change frequency.

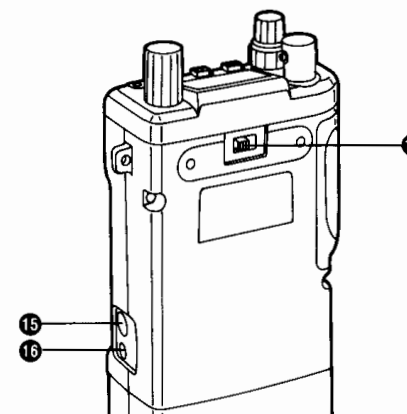

- (b) PRI, MS PS (Priority, Memory Scan Program Scan) Key

- (1) Press the PRI key to enter Priority mode. (See Priority function).

- (2) Press and hold the F key then press MS PS

- (a) If the Unit is in Memory mode, you will enter Memory Scan.

- (b) If the Unit is in the VFO mode, you will enter Program Scan.

- (c) SQL OFF, BS (Squelch Off, Battery Save) key.

- (1) Press this key to disengage squelch. Release key to re-engage squelch.

- (2) Press and hold the F key then press BS key for Battery Save function (See Battery Save function).

- (d) Lamp Key-Press this key to turn LCD Lamp on. (See Lamp Function).

15 DC in Jack

This jack is for accessing the 13.8 V power source from the outside. ALINCO's optional accessories (EDC-13 or EDC-16) are recommended.

16 MIC Jack

This jack is for an extension microphone. ALINCO's optional accessories (EME-4 or EME-2) are recommended.

17 H/L (High/Low) Switch

This switch is for changing transmission power from High to Low (or visa versa). The "H" side (left position) is High, and the "L" position (right side) is Low.

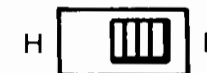

LCD Panel

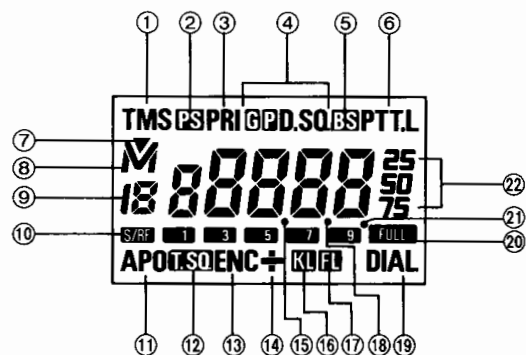

① TMS (Time Scan)

Press and hold the "F" key, then press TMS key, TMS will appear on the LCD. When TMS is ON, the timer scan is activated. When TMS is OFF, the busy scan will be activated.

② PS (Program Scan)

Press and hold the "F" key, then press the MS PS key. PS will appear on the LCD. This function will be accessed only in the VFO mode.

③ PRI (Priority)

Press the PRI key. PRI will appear on the LCD

④ DSQ (DTMF Squelch)

Press the hold the "F" key, then press the G P DSQ key. D.SQ will appear on the LCD. (See DSQ Function).

⑤ BS (Battery Save)

⑥ PTT.L

(Press To Talk. Lock)

Press and hold the "F" key, then press the PTT.L key. PTT.L will appear on the LCD. Transmission is locked out, and will not be activated even if the PTT switch is pressed accidentally.

⑦ Memory Skip

Press and hold the "F" key, then press the "M.Skip" key. ▼ will appear above the M (Memory) during memory scan. The memory number with will be skipped.

⑧ V/M

Press the V/M key. V. and M. will appear alternately on the LCD. V is in VFO mode and M is in the memory mode. Flashing M means that a frequency is not stored in the memory number yet.

⑨ Memory Number

This unit has a 20 memory capacity (0 through 19), and 1 call channel is activated, Memory channel Number will be replaced with C.

⑩ S/R.F

(Signal/Radio Frequency)

Indicates relative signal strength during receiving, and the relative RF level during transmission.

⑪ APO

(Automatic Power Off)

Press and hold the "F" key then press the APO key. APO will appear on the LCD. The unit will automatically shut off its power after 30 minutes. (See APO function).

⑫ T.SQ (Tone Squelch) — Optional

Press and hold the "F" key, then press the T.SQ key. T.SQ will appear on the LCD. (See Tone Squelch function)

⑬ ENC (Encoder)

Press and hold the "F" key, then press the ENC key. ENC will appear on the LCD. (See Tone Encoder Function).

⑭ "+/-" (Transmit Shift)

Press and hold the "F" key then press the "+/-" key.

- (1) Press "+" (plus) will show on LCD
- (2) Press "-" (minus) will show on LCD
- (3) Press again, and no symbol on LCD. (See Repeater Offset Function for details).

⑮ "●" (Decimal Point)

The Decimal Point divides MHz and 100 kHz, when the radio is in the VFO or Memory mode. It also divides MHz and 100 kHz for Repeater Offset.

The decimal point will flash when the unit is in the Scan mode.

⑯ KL (Key Lock)

(See PTT Key Lock function)

⑰ FL (Frequency Lock)

(See Frequency Lock function)

⑱ "●" (Tone Frequency Decimal Point)

This decimal point divides KHz and Hz in the Tone Frequency mode.

⑲ DIAL

Press and hold the "F" key then press the DIAL key. DIAL will flash on the LCD without the frequency. The unit can then store up to 16 digits (numbers) or characters (letters, including "#" and "*").

⑳ FULL (S/R.F Meter)

If transmission or reception power is at maximum, the FULL indicator will appear on the LCD.

㉑ "●" (Unlock Dot)

When a display frequency is unlocked, this dot will be displayed on the LCD.

㉒ LCD Panel

FUNCTION & OPERATIONS

Initial Setting:

Factory setting is 5 kHz. (DJ-162TD) or 12.5 kHz. (DJ-162ED)

Frequency Selection:

1. Dial

- A. Rotate the dial clockwise, 5 kHz (12.5 kHz) will be increased by one click. Counter Clockwise rotation decreases by 5 kHz (12.5 kHz).
- B. Press and hold the "F" key then rotate the dial, frequency increases or decreases by 1 MHz.

2. or buttons

Press the UP button, frequency will increase by 1 MHz. Press and hold the "F" key, then press the 1 MHz button and frequency will decrease. Same procedure applies for the 100 kHz button.

3. * or # keys on the front key pad.

Press the ▲ key, 5 kHz (12.5 kHz) will be increased. Press the ▼ key, 5 kHz (12.5 kHz) will be decreased. (If you hold these keys from 1–3 seconds, the radio will go into the scan mode.)

4. 16 Key Pad Direct Input

Number 0 through 9 will be punched in and displayed on the LCD, (less than 130.00 or more than 173.995 will not be accepted.

To enter the desired frequency follow the below steps.

- (a) Make sure the unit is in the VFO mode ("V" and channel number will be displayed on the LCD), or in the "M" flashing mode.
- (b) If "M" (memory channel number) stays on the LCD, 0 through 9 on the display will not accept direct input.
- (c) If the unit is more than 10 kHz step, the last kHz will not be input.
- (d) To cancel unfinished input, press the C key.

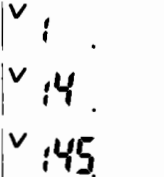
(Ex.) 

Receiving and Transmitting

1. Confirm:
 - (a) Insert 6 of AA drycell battery into battery case.
 - (b) The supplied antenna is properly connected to the BNC adaptor.
2. Volume control must be ON.
3. Adjust the volume control to desired level.
4. Adjust the Squelch control until white noise is off.
5. Select the desired frequency.
6. Press and hold the PTT switch and talk into the microphone (appx. 5" distance).
7. To get the unit in receive mode, release the PTT switch.
8. Select transmit power, either the Hi or Low, on the back side of the unit.

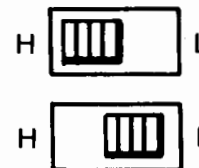

VFO Mode and Memory Mode

1. To put the radio in the VFO mode from the Memory mode, or CALL channel mode, press the V/M key.
2. To put the radio in the Memory mode from the VFO mode or CALL Channel mode, press the V/M key. "M" will flash (with no stored frequency).
3. Put the radio in the VFO mode when you want to input any functions into the unit.

Memory mode

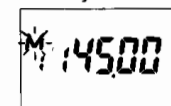

VFO mode

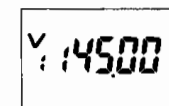

CALL Channel

To put the radio in the CALL Channel mode, press the CALL key. "C" will appear on the LCD. Press the key again and the unit will return to VFO or Memory mode. To cancel the CALL mode, press the CALL key or the V/M key.

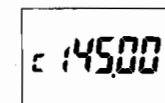

How to re-write a CALL Channel frequency.

1. Put the radio in the CALL Channel mode. (Press the CALL key.)
2. Press and hold the "F" key, then press the MW key. "C" indicator on the LCD will flash and a beep will sound.
3. Change a desired frequency by the frequency selection method.
4. Press and hold the "F" key and press the M/W key. The "C" will stay and the flashing will cease. Then the desired frequency is stored in the Channel C.

EX: (DJ-162TD)

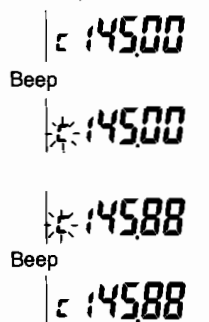

Memory Operation

1. The DJ-162 has 20 memory capacity. (Memory No. 0 to 19.)
2. 145,000 MHz is the factory setting. Or 145,000 MHz will appear after the radio is reset.

How to put the Radio in Memory mode.

1. Press the V/M key. The flashing "M" will appear on the LCD instead of "V".
2. Rotate the Dial to select a Memory Channel number. Or press the M key. (If this key is kept depressed for over 2 seconds, the radio will automatically move to the Scan mode.)

How to write a frequency into the Memory Channel.

- A) When the radio is in VFO mode.
1. Press the V/M key and select "M" flashing. (This is an open Memory Channel.)
 2. Select a desired frequency using 10 keys (0 to 9) on the DTMF 16 key pad or the \blacktriangle MHz, \blacklozenge 100 kHz keys.
 3. Press and hold the F key then press the MW key. The memory Channel number with "M" flashing will stop. "M" will stay on.
 4. When the radio is in the Memory mode, and "M" stays on the LCD. This means the Memory Channel number is already stored a frequency number. To change the frequency in this Memory Channel number.
 - (1) Press and hold the "F" key and press the MW key. "M" will start to flash.
 - (2) Follow the above steps No. 2 & 3.

EX: (DJ-162TD)



- B) When the radio is in the Memory mode.

1. Select an open memory channel.
2. If there are no more open memory channels (or you want to change a previously entered memory setting), press and hold the F key, then press M/W key for the flashing "M".
3. Follow steps No. 4 above.

SCAN Function

There are two basic scan functions (1) Memory Scan, and (2) VFO Scan. VFO Scan includes BAND & PROGRAM scanning capabilities.

BAND SCAN

1. Press and hold the V/M key and put the radio in VFO mode. "V" will appear on the LCD.
2.
 - (a) Scan by 1 MHz. Press and hold the \blacklozenge MHz, key 2 seconds. The band scan will start upward by the 1 MHz and repeat the scan the band. To stop this scan press the \blacklozenge MHz key again.

To start the scan downward press and hold the F key and press the \blacklozenge MHz key. The scan will start downward. To stop the scan press the \blacklozenge MHz key again. If the \blacklozenge MHz key was kept pressed more than 3 seconds after the unit will start to scan, the radio will not scan.

- (b) **Scan by 100 kHz** The same procedure is taken the above using the \blacklozenge 100 kHz key instead of the \blacklozenge MHz key.

- (c) **Scan by Step** See steps in Operations. Press the \blacktriangle key to start scan upward. Press the \blacktriangledown key to start scan downward. To stop the scan press these keys again.

EX: (DJ-162TD)

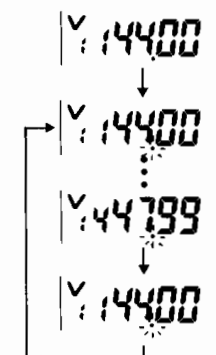

MEMORY Scan

1. Press the V/M key and put the unit Memory mode. "M" will appear on the LCD.
2. Press \blacklozenge M key for 2 seconds. Memory Scan will start. To stop the Memory Scan press the \blacklozenge M key again. If the \blacklozenge M key is kept pressed over 3 seconds after Memory Scan has been started, memory scan will not start.
EX: (DJ-162TD)

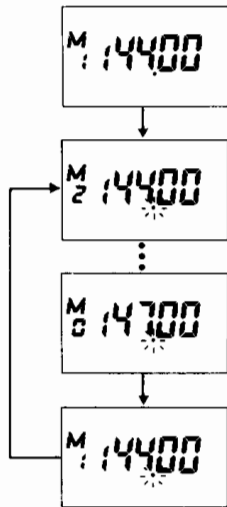

Note:

The above Band Scan and Memory Scan will stop at a signal presented on the frequency of Memory Channel numbers. The radio will not scan until the signal goes off. When you want to change a frequency of Memory Channel number while the unit stays on the busy frequency, just click the Dial clockwise until the signal goes off. Then the unit will start to scan upward again. If the Dial was rotated counter clockwise, the scan will start downward again.

MEMORY Scan Skip

This function is used to skip Scan which a Memory Channel number is not to be scanned. This function is accepted when the unit is in Memory mode. "M" appears on the LCD.

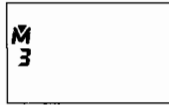

To set up a Memory Channel Skip

1. Select a Memory Channel number which you don't want to be scanned by rotating the Dial or pressing the \blacklozenge M key.
2. Press and hold the F key then press the M.SKIP key.
3. When the unit is in Memory Scan mode, the Memory Channel number will be skipped. To let the unit scan the Memory Channel number again:
 - (a) Stop the Memory Scan.
 - (b) Get the skipped memory Channel number on the LCD.
 - (c) Press and hold the F key then press the M.SKIP key.

EX: (DJ-162TD)

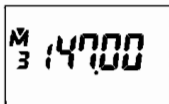

REPEATER Operation

The unit has 38 subaudible encoding tones from the factory. (DJ-162TD) To operate the radio through an open (public) repeater the radio needs to set up + or - offset and also difference of transmit and receiving frequency. To operate the radio through closed (private) repeater the radio needs to set up + or - difference of TX and RX frequency and proper tone frequency, according to the repeater.

How the set up the radio to operate through a repeater.

- (1) Select a receiving frequency according to a repeater's frequency.
- (2) Select an **offset frequency**. See Offset Selection.
- (3) Select a shift (+ or -). See Shift Selection.
- (4) Select a tone frequency. See tone frequency selection.
- (5) Press the PTT switch the selected above frequency will be transmitted with for-offset frequency and tone frequency.

Offset Selection

This radio has free Offset from 0.00 MHz to 99.995 MHz. (To put this mode stop a Scan mode.)

To select an offset

- (1) Press and hold the F key then press the OFFSET key. EX. 000.60 will appear on the LCD. You can release the F key.
- (2) Rotate the dial or press the \blacklozenge MHz key or the \blacklozenge kHz key to change an offset frequency.

- (3) Press and hold the F key then press the OFFSET key, or simply press the V/M key. The desired receiving frequency will appear on the LCD.

Note:

An offset frequency is used for VFO mode and Memory Channel No. 0 to 16. So if you change an offset frequency in VFO mode, the offset frequency in the Memory channel No. 0 to 16 will change to the offset frequency which was changed in the VFO. EX 0.80 MHz in memory channel NO. 0 to No. 16. If you store EX. 0.60 in VFO, The 0.80 MHz will be changed to 0.60 MHz.

- (4) Any offset will be able to store in memory channel no.'s 17 to 19.

Tone Frequency Selection

The DJ-162TD has 38 different tone frequencies listed below.

- (1) Press and hold the F key and press the TSQ SET key.
- (2) Hold the F key, rotate the dial or press the ▲ or the ▼ key.

67.0	71.9	74.4	77.0	79.7	82.5
85.4	88.5	91.5	94.8	97.4	100.0
103.5	107.2	110.9	114.8	118.8	123.0
127.3	131.8	136.5	141.3	146.2	151.4
156.7	162.2	167.9	173.8	179.9	186.2
192.8	203.5	210.7	218.1	225.7	233.6
241.8	250.3				

38 different tone frequency will be displayed on the LCD. EX 67.0, 233.6, 250.3, and so on. Please read these figures with Hz.

- (3) When the F key is released VFO or memory mode will appear on the LCD.

Shift (+ or -) selection

Selecting this + or - direction transmit will increase (+) or decrease (-) from receiving frequency.

- (1) Press and hold the F key the press the key. By pressing +..., -..., Blank (This means Simplex mode) will rotate on the LCD.

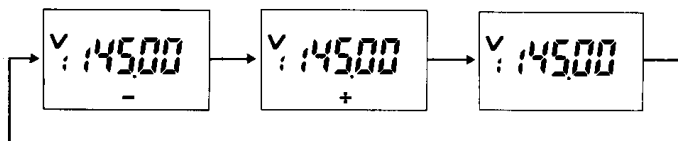

Note:

The radio will transmit desired commands to open a repeater using the required offset. Tone Frequency and Shift Direction explained the above. When displayed "OFF" during transmit, selected offset is too much. The unit will not transmit.

Channel Step Selection

How to Select a Channel Step

1. Press and hold the F key then press the STEP key. (This function will work in any mode ie: Memory, VFO or CALL, it will not work in any scan mode.)
2. Keep pressing the F key, rotate the dial or press the ▼ key or the ▲ key. Channel step will be changed the listed below.

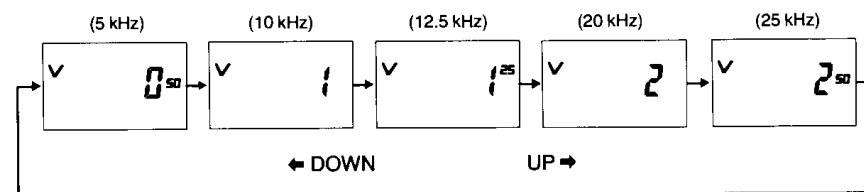

3. Release the F key after the desired step is selected. VFO memory or Call mode will appear on the LCD.

Note:

If you select EX 1.25 (12.5 kHz) step after the 0.5 (5 kHz) step has stored in memory channel number 1. The 0.5 (5 kHz) step will be changed to 1.25 (12.5 kHz) in memory channel #1.

SCAN Operation

Busy Scan or Time Scan will be selectable for these Scan modes. You can choose Busy Scan or Time Scan in the Band Scan, Program Scan or Memory Scan modes.

Selection of Busy Scan or Time Scan

Busy Scan:

Scan will stop when a signal is present and stay until the signal goes off. The unit will resume scanning after 2 seconds pause of going off the signal.

Time Scan:

Scan will stop when a signal is present and stay for 5 seconds even if the signal stays. The unit will start to scan again after 6 seconds even the signal stays.

To press and hold the F key and press the TMS key. The "TMS" will appear on the LCD. If the "TMS" is displayed on the LCD, the unit will scan (Band, Program, or Memory), by Time Scan way.

Press and hold the F key and press the TMS key again. The "TMS" will disappear on the LCD. The unit will scan (Band, Program, or Memory) by Busy Scan way.

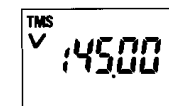

Band Scan Function

1. See scan function described before.

Program Scan Function

This function lets the unit scan between desired two frequencies.

1. Press the V/M key and select VFO mode.
2. Store desired upper and lower frequency in Memory Channel 0. EX. 144.555 MHz.
3. Press the V/M key again and select VFO mode.
4. Select desired lower or upper frequency. EX. 144.000 MHz.
5. Press and hold the F key then press the MS PS key. "PS" will appear on the LCD.
6. Program scan will start at the same time "PS" appears on the LCD.

Memory Scan Function

This function allows scanning of occupied Memory channels.

How to Stop The Scan Functions

Press \blacktriangle M or \blacktriangle MHz or \blacktriangle 100 KHZ

During these scanning operations (Band, Program, or Memory) you can change scan direction, upward to downward or visa versa, by rotating the dial. Also the unit accepts a change from Time Scan to Busy Scan or visa versa by pressing and holding the F key then pressing the TMS key.

PRIORITY Function

The DJ-162 has 3 different types of Priority Functions, such as VFO Priority, Memory Priority, and CALL Priority.

(A) VFO Priority:

This function lets the radio scan one Memory Channel for one second in VFO mode.

- (1) Press the V/M key and select the Memory mode for one second at VFO mode.
- (2) Select a memory Channel by rotating the dial or pressing the \blacktriangle M key.
- (3) Press the V/M key and select VFO mode.
- (4) Select a desired frequency on VFO.
- (5) Press the PRI key. "PRI" will appear on the LCD.
- (6) The unit will start to scan the memory channel one second and stay on VFO for 5 seconds.

- (7) When a signal presented on the memory channel the unit will beep and stay 3 seconds on the memory channel.
- (8) To cancel this function press the PRI key when the unit is on VFO mode. The "PRI" will disappear on the LCD.

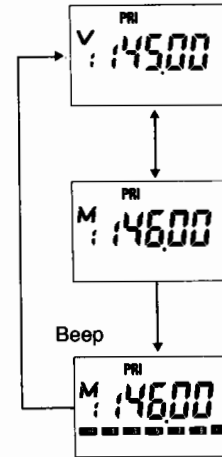

(B) Memory Priority:

This function lets the unit scan VFO mode one second and memory channel 5 seconds. This function is the opposite of VFO priority function.

- (1) Press the V/M key and select VFO mode.
- (2) Select a frequency which is desired to scan one second.
- (3) Press the V/M key and select memory mode.
- (4) Press the PRI key. The "PRI" will appear on the LCD.
- (5) The unit will scan the frequency on VFO open second and stay on memory mode 5 seconds. When a signal presented on the frequency on VFO the unit beeps and stays VFO 3 seconds.
- (6) To cancel this function press the PRI key when the unit is on memory mode. The "PRI" will disappear on the LCD.

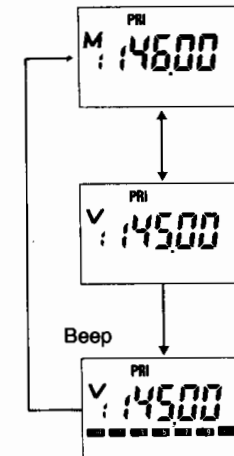

(C) CALL Priority:

There are 2 CALL priorities, One for use with the VFO, and the other for use with the Memory.

This function lets the unit scan VFO or Memory one second and CALL Channel 5 seconds.

- (1) Press the V/M key and select VFO mode or memory mode which is desired to scan one second.
- (2) Press the call key. The "C" will appear on the LCD.
- (3) Press the PRI key. The "PRI" will appear on the LCD.
- (4) The unit will scan VFO or Memory mode one second and stay on CALL Channel 5 seconds.
- (5) When a signal presented on VFO or Memory the unit will beep and stay 3 seconds on VFO, or Memory. After 3 seconds the unit will repeat to scan.
- (6) To cancel this function press the PRI key at CALL Mode. The PRI will disappear on the LCD.

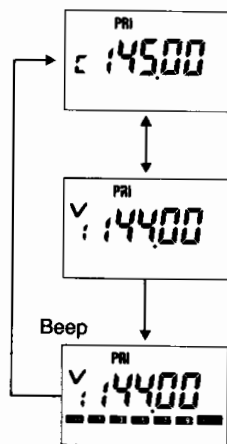

The following operations will be acceptable during the above different Scans.

- (1) Transmit on 5 second mode. Press the PTT key, the priority Scan will resume again.
- (2) Transmit on one second mode. Press the PTT key, a frequency on modes of one second will be transmitted. The priority scan will be cancelled after transmitted.
- (3) The and dial will be acceptable to change a frequency or memory channel number.
- (4) To cancel Priority Scan Function. Press the PRI key or V/M key at modes of 5 seconds. Press the PTT key at modes of one second.

Simultaneous Operation for Intermix of Scan and Priority:

1. Band Scan and Memory Scan: This function lets the unit repeat Memory Scan and Band scan at VFO mode.
 - (a) Press the PRI key during the unit is in the Band Scan mode. The unit will scan a memory channel one second during the scan bands.
 - (b) During the VFO priority scan press the UP/DOWN key with 2 seconds. The unit will start to band scan. The unit will scan a memory channel one second during the unit keeps band scan.
2. Memory Scan and memory Priority Scan: This function lets the unit repeat Memory Priority Scan and memory Scan at Memory mode.

- (a) Press the PRI key during the unit is in memory scan mode. The unit will scan a frequency in VFO one second during the scan memories.
- (b) During memory priority scan press the M key 2 seconds. The unit will start to memory scan. The unit will scan a VFO frequency one second during the unit keeps memory scan.

CANCELLATION OF PRIORITY:

Press the PRI key at 5 second sides. The "PRI" will disappear.

CANCELLATION OF SCAN:

Press the UP/DOWN key at 5 seconds side. Scan will be cancelled. Or press the PTT key. Scan will be cancelled.

CANCELLATION OF PRIORITY AND SCAN BOTH:

Press the V/M key at 5 seconds side, or press the PTT key at 1 second side.

Dual Watch Function:

This function lets the unit receive alternately between CALL Channel, and VFO or Call Channel and memory for 3 seconds.

1. Press the V/M key and select VFO mode or Memory mode.
2. Select a desired frequency on VFO or memory channel.
3. Press the Call Key. Store desired frequency in Call channel.
4. Press and hold the F key then press the PRI key.
5. The unit repeat scan the 2 different modes alternately.
6. To cancel this function press the V/M key.

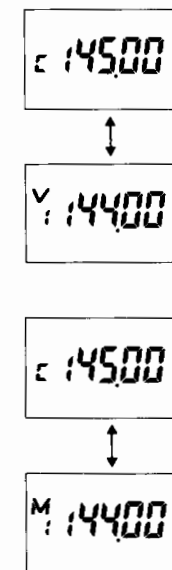

The following operations are acceptable during the Dual Watch function.

1. Press the PTT key at either mode. A frequency will be transmitted.
2. After 5 seconds later the releasing the PTT key, Dual watch function will start again.
3. Rotate the dial to change a frequency when the unit is in VFO mode. Rotate the dial to change a memory channel when the unit is in memory mode.

Reverse Function

This function is used to exchange a transmit frequency and a receive frequency when repeater operation for confirming whether input frequency is busy or not.

1. Press the V/M key. Select VFO mode.
2. Select a desired frequency, offset and + or - direction. EX, 146,40 0.60 "+".
3. Press and hold the F key and press the REV key. A frequency will be added or subtracted by direction. Also the direction will be reversed. EX. (DJ-162TD)

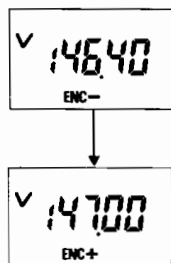

Tone Encoder:

This function is used to open a repeater if required. Select a required tone frequency "ENC" direction + or -. When the PTT is pressed the frequency will be transmitted with tone frequency.

1. Press the V/M key. Select VFO mode.
2. Select a frequency, offset and direction.
3. Press and hold the F key and press the ENC/TSQ key. The "ENC" will appear on the LCD. Select a required tone frequency. See Tone Frequency.
4. To cancel Tone Encoder Function press and hold the F key then press the ENC/TSQ key. The "ENC" will disappear on the LCD.

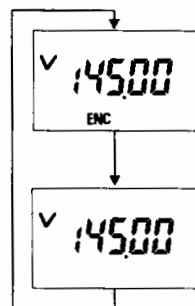

Tone Squelch:

This function is used to open the DJ-162 squelch when the other party's tone frequency is the same as the DJ-162 (Tone Squelch unit EJ-6U is available as an option accessory).

1. Put a tone squelch unit EJ-6U into the DJ-162 according to its instruction.
2. Press and hold the F key and press the ENC/TSQ key. The following is displayed each time on the LCD.

3. Select ENC/TSQ. The "TSQ ENC" will appear on the LCD.
4. Select a required tone frequency.
5. When the PTT is pressed the unit will transmit a frequency with tone frequency.
6. At receive mode the unit will only receive the same frequency and tone frequency as the DJ-162 has. If the tone frequency is different from a tone frequency the speaker will remain muted.

(EX.)

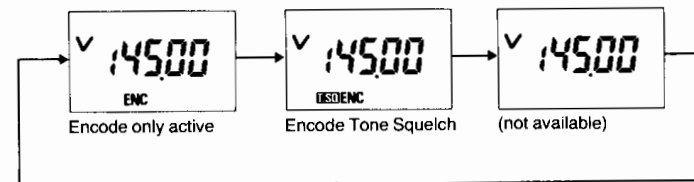

DSQ (DTMF Squelch)

Function:

This function is used as a page or code squelch.

Pager Function:

1. Page for group: This function is used to page for some limited group.
2. Page for preselected individuals: This function is used to page an individual pre-selected by the user.

Code Squelch Function:

By transmitting a frequency with 3 digits code the unit will be operating the same function as a tone squelch function.

DSQ Code:

- (1) 3 Digit code for members: This 3 digit code has 2 different functions, One for a code for members as a pager function. One for a code for a code squelch function.

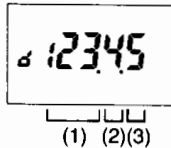

- (2) 1 Digit for oneself code: This 1 digit code is for oneself.
- (3) 1 digit for other party code: This 1 digits code is used to page one of a particular person in the member. When the unit receives a signal by the pager function the unit will keep the party's code number automatically.

Selection of DSQ Code:

1. Press and hold the F key then press the DSQ Set key. d000.0.0 will appear on the LCD. The first 3 digits are for members code, second 1 digits is for oneself code, the third 1 digits code is for other party code.
2. Desired code is input from the left hand side.
0 through 9, A, B, C, D, * and # on the DTMF pad will be accepted for the code. (* will be displayed $\#$ and # will be displayed $\#$ on the LCD.)

Note:

mark as a code has a special meaning. See DSQ Operation Function.

3. To input codes you may release the F key.
4. To clear input code press and hold the F key, then press the DSQ SET
5. To re-write codes press and hold the F key, then press the DSQ SET key again.
6. After 5 codes are input, press the V/M key. The unit will beep and the 5 codes are stored.

Selection of DSQ:

This function is used to page members or particular person.

1. Press and hold the F key then press the GPDSQ Key. A method of DSQ will be indicated on the LCD as below:

(EX.)

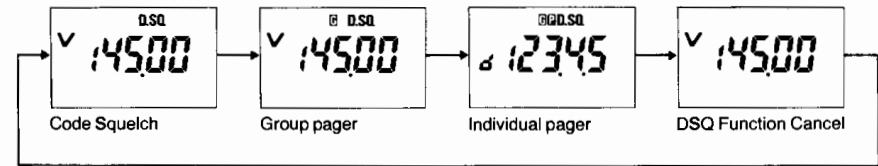

2. Pager Function for groups
 - (a) Input 5 codes according to the DSQ code selection.
 - (b) Press and hold the F key and press the GPDSQ key. Select the "G DSQ" on the LCD.
 - (c) Press the V/M key. VFO mode will appear on the LCD.
 - (d) Select a desired frequency.
 - (e) If the PTT key is pressed the entered first 3 codes (DTMF) for groups and the fourth digit (DTMF) for individuals will be transmitted along with the frequency.

(EX.) VFO Mode 145.555 MHz 5 digits codes 12389
Member code 123 and oneself code 8 will be transmitted with 145.555 MHz. (123*8***)

Note:

If the "GPDSQ" is displayed on the LCD, the only last digit accepts code entry. Press the V/M key VFO mode will appear on the LCD.

3. Pager Function for a particular person.

This function is used to page to a particular person.

 - (a) Input 5 codes according to selection of DSQ code.
 - (b) Press and hold the F key and press the GPDSQ key. Select the GPDSQ on the LCD.
 - (c) Press the V/M key. VFO mode will appear on the LCD.
4. Select a desired frequency.
5. If the PTT key is pressed the entered first 3 codes (DTMF) for groups, the fourth digit (DTMF) for individuals and the last digit (DTMF) for individuals will be transmitted along with the frequency.

(EX.) VFO mode 144.885 MHz 5 digit codes 23567
(2357*6)

4. Pager Function for Receiving.

- (a) Select 5 digit code
- (b) Select "G DSQ" for groups or "GPDSQ" for individuals.
- (c) Select a chosen frequency.
- (d) When the unit receives the same frequency and group codes (DTMF) the unit will beep 5 seconds. The "G" will start to flash. This means someone is paging you.
- (e) When the unit receives the same frequency, member code (DTMF) and oneself code (DTMF), the unit will beep 5 seconds. The "G" and "P" will start flashing.
- (f) Press the PTT key and possible to communicate if the other party's radio is on.
- (g) To turn off the beep, press the V/M key. The flashing "G" or "GP" will stay on the LCD.
- (h) If a group's code is not received by mixed signal, the ERR will appear on the LCD. Even though press the V/M key then VFO frequency will appear on the LCD. And it is possible to communicate with the group.

5. Code Squelch Function

This function is used for page in groups.

- (a) Select first 3 digits for groups.
- (b) Press and hold the F and press the GPDSQ key. And select the "DSQ" on the LCD.
- (c) Select a chosen frequency on the VFO.
- (d) Press the PTT key. The unit will transmit a 3 digit code (DTMF) along with the frequency.

- (e) When the unit receives the same frequency and group code (DTMF) the unit will open the squelch and the DSQ will start to flash. It is then possible to communicate.

Caution for DSQ Function:

1. When receiving signal is clipped: If the DJ-162 is on receive mode by code squelch/pager function, it is possible to communicate within 1.5 seconds after a received signal is clipped.
2. Time to transmit code: It takes about 450 m seconds after the PTT is pressed.
3. Time to transmit code squelch and code: It takes about 350 m seconds after the PTT is pressed.
4. Adjusting the Squelch: Adjust squelch at threshold.
5. During a DSQ code or dial no. is displayed on the LCD don't take DSQ function. The unit must be VFO mode when the unit is in DSQ receiving mode.

Additional Feature of DSQ Function:

The DJ-162 is designed to page any particular person (private pager) with a one digit code. However, some other manufacturers have designed their radio to operate with a three digit code. For your convenience the DJ-162 is also compatible for three digit code, and then can be used with the other models. You can set up the three digit code for yourself in the unit.

Set Up Three Digit Code

- 1) Press and hold the F key, then press the DSQ Set Key.
- 2) If a group code is also necessary, store three digits.
- 3) Press the V/M key. A VFO mode will be displayed on the LCD.
- 4) Press and hold the F key, then press the DIAL M Key. The "DIAL" will flash.
- 5) Rotate the Dial or press the \blacklozenge M key and get Dial Memory 2. M2 ~~K0XX~~ will be displayed on the LCD.
- 6) Press the \blacklozenge MHz key 3 times. While depressing the F key M2 ~~0XX~~ will be displayed.
- 7) Store 3 digits pressing 16 digits DTMF pad.

After you finished 1 through 7.

- 1) Press the \blacklozenge 100 kHz key until any code on the LCD disappears.
- 2) Store three digit code by pressing the DTMF pad.
- 3) After you finished the above 1-7 or 1-2 press the V/M key. VFO mode will be displayed on the LCD.

To Receive a Frequency with a Three Digit Code

Press and hold the F key then press the GP DSQ key until the G DSQ will be displayed on the LCD. If the unit received the same frequency with same code, the unit will beep and change the display on the LCD to P DSQ instead of G DSQ. If you want to communicate with this signal, press the PTT then you can communicate.

DTMF Display Decoder Function:

This is function to display DTMF decoder in DIAL No. 3 on the LCD.

- 1) Select a Frequency EX. 144.555
- 2) Select the DSQ on the LCD
(or)
 - 1) Select a Frequency EX. 144.555
 - 2) Store any Codes up to 16 digits in the Dial No. 1 and/or Dial No. 2 according to Dial Function.

If the unit receives a signal from a DTMF decoder it will be displayed on the LCD. To make sure you are set in the DTMF decoder, press the DIAL CH key then rotate the dial and get the DIAL No. 3. The DTMF decoder will be displayed on the LCD.

Wild Card Function:

This function is used when you forget a group code number (all three digits or partial), or a Code Squelch Function.

1. Select DSQ Code No. d 000.0.0 will be displayed on the LCD.
2. Press the # key 3 times and **000** will be displayed on the screen.
3. Press the V/M key, VFO mode will be displayed.
4. Select G DSQ according to DSQ function.

The unit will receive the same frequency and group code DTMF frequency. A forgotten group code will be displayed on the LCD in place of the **000**.

DIAL Function:

This function is to access an autopatch. The unit accepts up to 16 digits of code in Dial Memory 1 and Dial Memory 2.

Selection of DIAL No.:

1. Press and hold the F key and press the DIAL M key. The Dial will flash with M on the LCD. The unit is in Dial mode.
2. Rotate the Dial No. 1 and No. 2 will be changed alternately.

Input the 16 digit code:

0 to 9, A, B, C, D, * and # total 15 keys and are acceptable for input.

Correction of some code inputs

To display input code backward press the \leftarrow 100 kHz key. One digit will be back. To display input code forward press the \rightarrow MHz key. One digit will be forward. Display one digit up on the right hand side of the LCD. Input correct code the old code will be re-input on the LCD.

(EX.) 214376A809 If you want to change 5 instead of B, display "A" on the right side on the LCD. Press 5, the new number will be 214376A509.

Clear all code input digits.

Press and hold the F key and press the C key. The input digits will be cleared.



How to store a desired digit:

Press the V/M key after the desired codes correctly. The unit will beep and the digits have been stored in the selected Dial number. The unit will display VFO frequency on the LCD. The Dial will stop flashing and stay on the LCD. If displayed digits are not stored, the Dial will keep flashing. Do it again according to the above procedures.

Change of Dial Memory No. displayed on the LCD

Auto Dialer Function

This function is to transmit up to 16 digit code with a frequency. A code in Dial memory 1 or 2 will be transmitted. Press the PTT key then press the F key simultaneously. The unit will transmit a frequency with the code. When the unit is in DSQ mode the DSQ code will transmit with a frequency and then code in the Dial memory code will be transmitted. Dial memory code will be transmitted about 250 m seconds after the DSQ code.

Frequency Lock Function:

Press and hold the F key and press the K.L.FL key. The KL will appear on the LCD. In this function the dial, PTT, SQL OFF and Lamp keys are acceptable. No other keys are acceptable. Except the ALM key when the unit is beeping during the DSQ signal. To release this function take the same procedures as above.

PTT Key Lock Function:

Press and hold the F key, then press the PTT.L key. The PTT.L will appear on the LCD. The PTT key will not accept. All keys are acceptable to operate except the PTT.

Lamp Function:

Press the LAMP key; The LCD read out will be lit for 5 seconds. If there is key input, the light will remain for 6 seconds after the last input. Press and hold the F key and press the LAMP key. The LCD read out will be lit until the LAMP key is pressed again.

Auto Battery Save Function:

This is to save energy consumption, during the receive mode. With this function engaged, the unit will operate 700 m seconds, then sleep for 300 m seconds, then go back on again. Press and hold the F key and press the BS key. The BS will appear on the LCD. To cancel this function repeat the same procedure. The BS will disappear from the LCD.

Note: When the unit is in scan, Priority & Dual watch modes will not be effective.

Auto Power Off Function:

This function is to save the battery power. When an operator forgets to turn off the unit.

Press and hold the F key then press the APO key. The APO will appear on the LCD. If the unit has not received any signal or has been operating for 30 minutes, a 5 second beep will sound and only the APO will stay flashing on the LCD.

To cancel this function press and hold the F key and press the APO key again. The APO will disappear from the LCD.

Squelch Off Function:

Press the SQL OFF key. The unit will squelch out. The unit will make noise.

Reset Function:

This function is to put the unit in the initial mode. (All memory will be cleared.) Press and hold the F key and turn off the switch and turn on the switch again. The unit will display on the LCD the following:

VFO Frequency	145.00 MHz (DJ-162TD/ED)
Memory channel	1
Channel Step	5 kHz (DJ-162TD) 12.5 kHz (DJ-162ED)
Shift Direction	None
Offset Frequency	0.6 MHz (DJ-162/TD/ED)